



Beam Parameter Measurements

2005 INTERNATIONAL
LINEAR COLLIDER WORKSHOP



Stanford, California, USA 18-22 March, 2005

New Physics at TeV Scales
and Precision EW Studies

Eric Torrence
University of Oregon

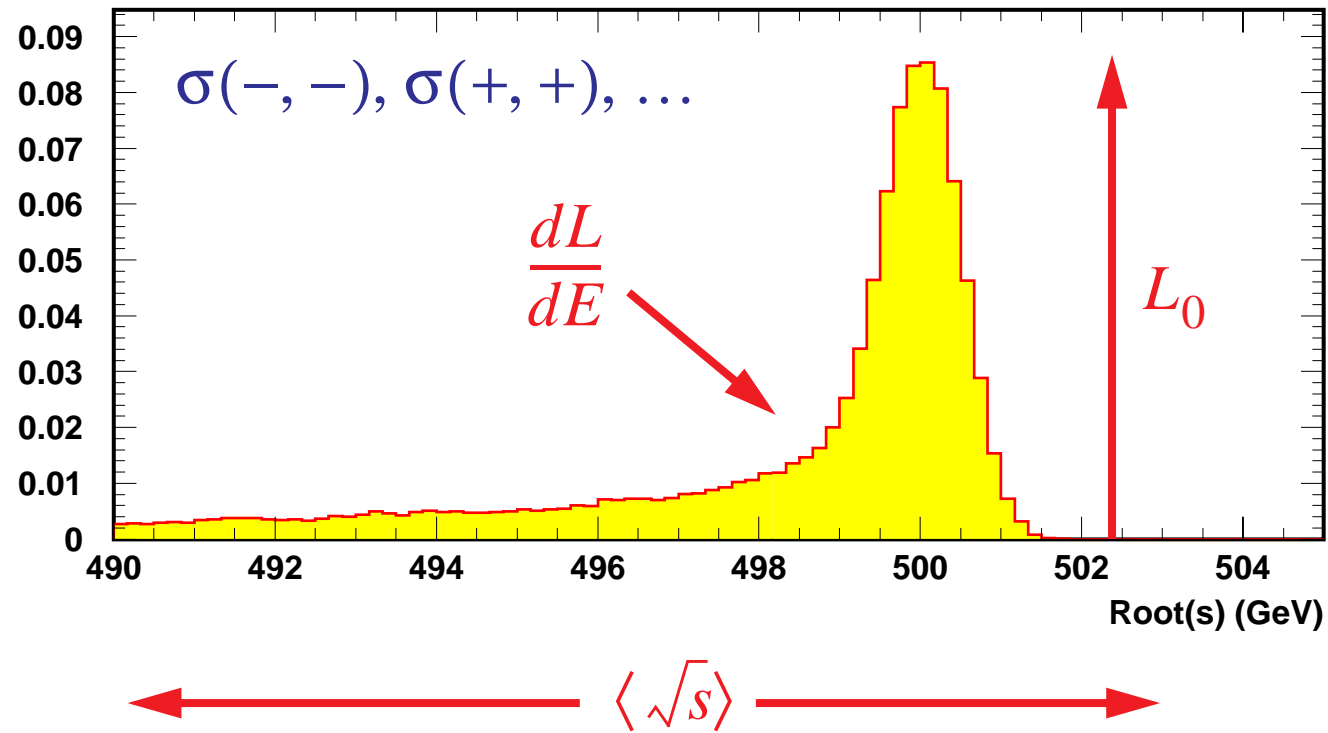

Fundamental Goal

Spin-dependent absolute collision energy spectrum

Typical Components

- Beam Energy
- Beam Energy Width
- Beam Polarization
- Absolute Luminosity
- Differential Luminosity Spectrum

All are intrinsically related in fundamental goal

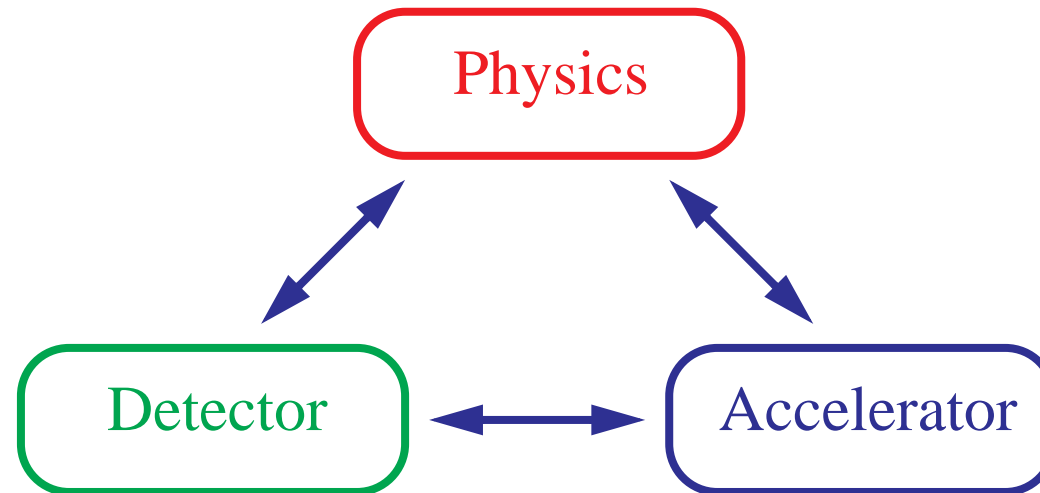

Must optimize between three often competing goals

Better performance is always preferred,
but resources are not infinite

Hard Questions

- What is mandatory?
- What has high benefit/cost?
- What is less compelling?

May be soon in a position to set priorities
and make some difficult decisions

Need solid input from the physics side ...



Goals often defined by what is considered “achievable”

- $\langle \sqrt{s} \rangle$ understood to 50-100 ppm - m_H, m_t, m_X

Beam energy necessary but not sufficient

- Polarization $\Delta P \sim 0.25\%$ - A_{LR} at high energy

Goal for polarimeter, could use better, 0.1% with P_+

- Absolute luminosity

ALCPG view: $\Delta L \sim 0.2\%$ (“easy”)

Tesla view: $\Delta L \sim 0.01\%$ (“very hard”)

LEP expt. 3.4×10^{-4} Theory 5.4×10^{-4}

Motivations given are σ_Z and $\sigma_{q\bar{q}}$

Baseline goals for high energy, high luminosity running

Use mixture of beam-based and physics-based observables

Redundancy is key to precision



Special Configurations



Dedicated runs can be taken with
“special machine configurations”

Examples

- $t\bar{t}$ threshold scan
- Mega/Giga Z running

Reduced energy spread, beam-beam effects
in return for reduced luminosity

With new ILC parameters table, should seriously
look at specific running and instrumentation scenarios

Word of Warning

Also must be ready for alternate situation:
Worse beam conditions for higher luminosity

Luminosity will trump almost all other considerations!



Beam Polarimetry

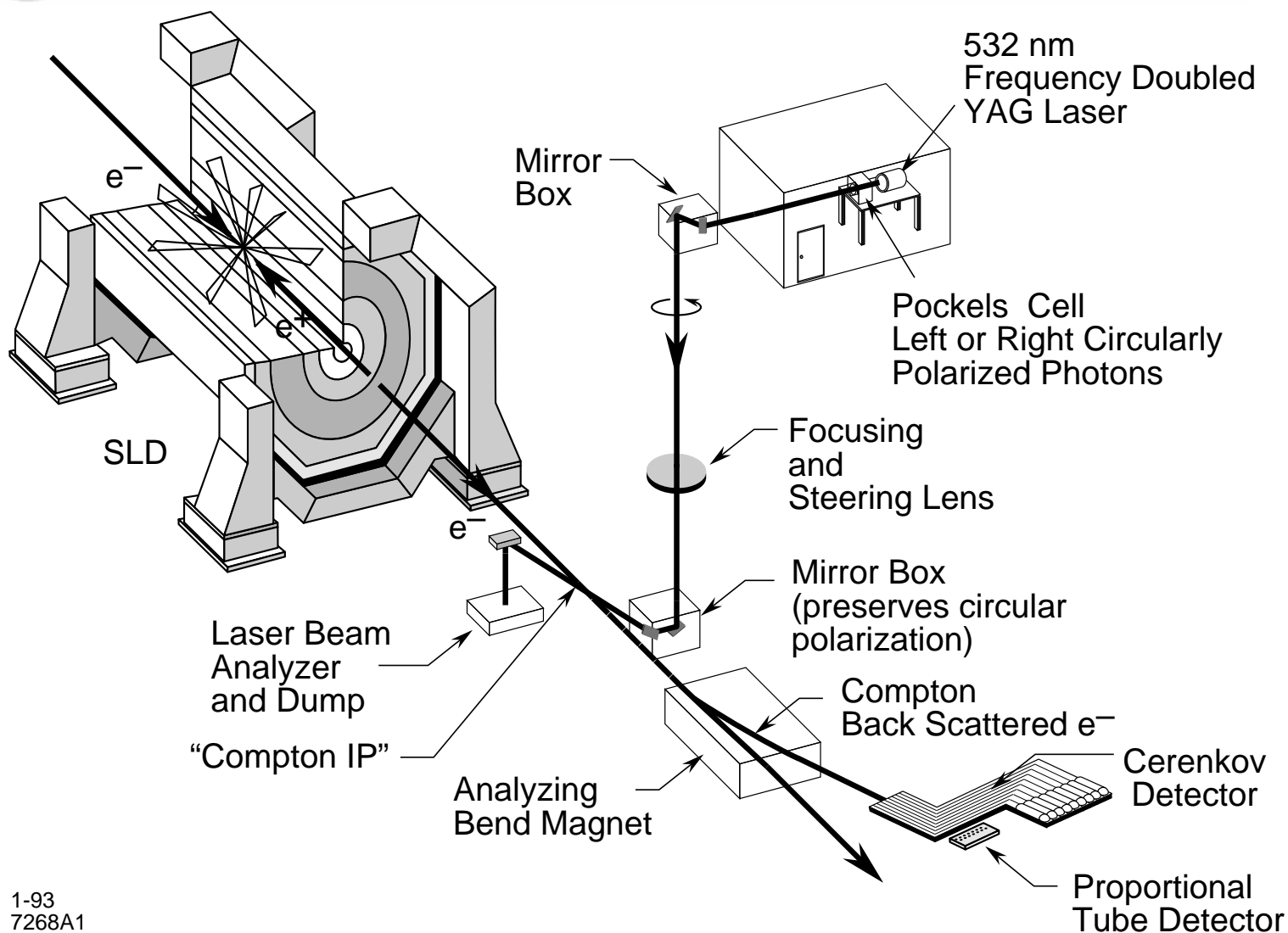

1-93
7268A1

Basic principle understood, **many details missing**

- **Upstream/downstream polarimeter or both?**
- **Depolarization effects**
- **Spin transport with 2 IPs**
- **Benefit of P_+ and helicity reversal time**



IP-Polarimeter differences



Depolarization in collision

- Sokolov-Ternov and BMT precession
- Overall lumi-weighted $\sim 1/4$ total depol.
- $\Delta P_{lum} \sim 0.5\%$, should be re-evaluated

IP-polarimeter spin precession

$$\Delta\theta = \gamma \frac{(g-2)}{2} \theta_0$$

- 1000x amplification, need spin vector longitudinal and parallel to $\sim 50 \mu\text{Rad}$
- Harder with 2 IPs (double spin rotators)
- Must worry about solenoid in x-angle

Downstream-Upstream argument

- Downstream allows direct measurements of depolarization effects
- Upstream closer to lum-weighted polarization
- Need separate polarimeter per IP, too expensive to do both?

New IP simulation (GuineaPig) with spin transport may help guide arguments here.

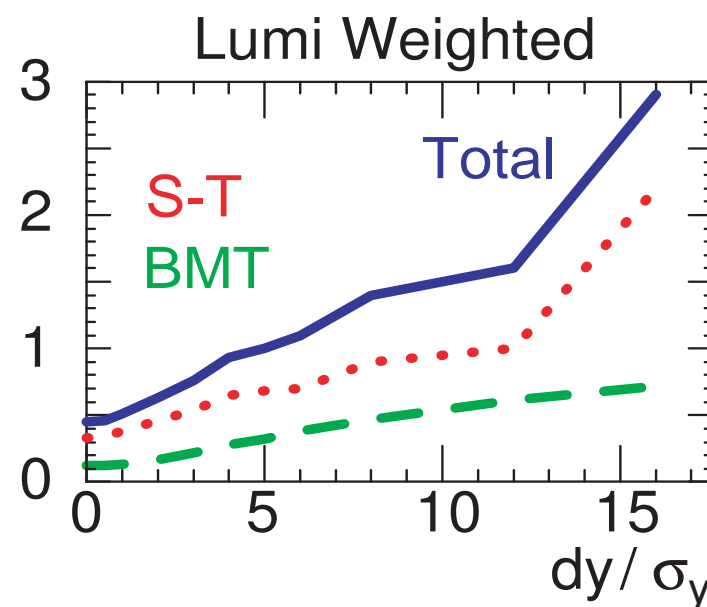
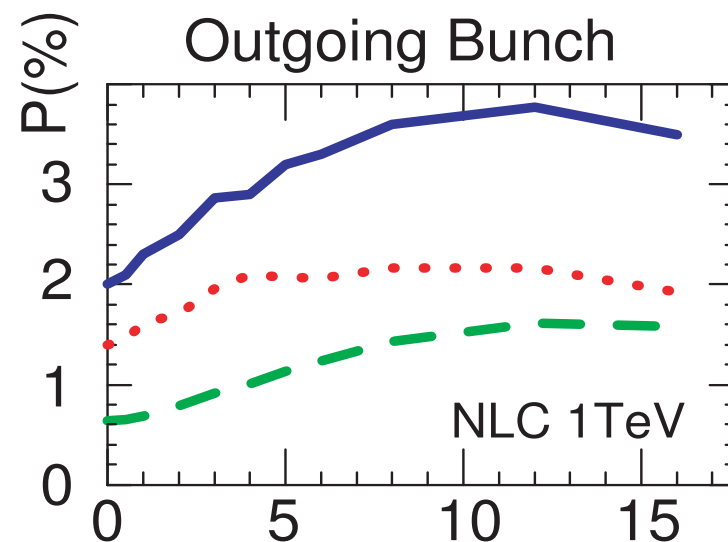



Positron Polarization



Error Propagation

$$P_{eff} = \frac{P_- + P_+}{1 + P_- P_+} \sim 93\% [80\%/50\%], \delta P_{eff} \rightarrow 0.1\%$$

Blondel Scheme

- Can directly extract P_{eff} from $\sigma_{++}, \sigma_{--}, \sigma_{+-}, \sigma_{-+}$
- Assumption that $\Delta P = P_- - P_+, \Delta L$ are zero

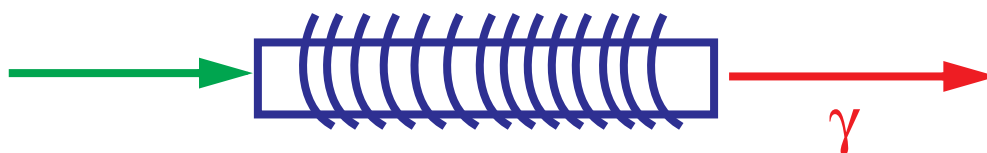

With undulator production, windings determine photon helicity - difficult to reverse P_+

Longer time between P_+ reversals means effectively independent beams

Increased reliance on absolute polarization scale...

Personal belief: only fast reversals will realize benefits of Blondel scheme



Physics Inputs

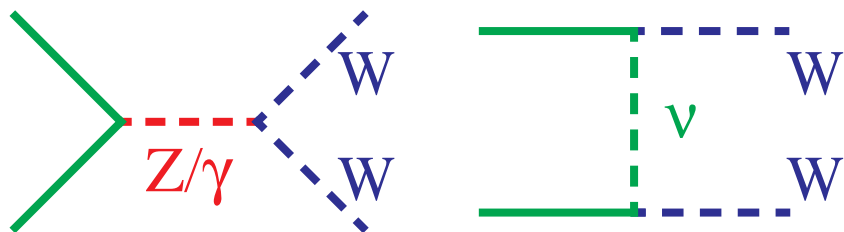

Use t-channel WW or single-W
as lumi-weighted polarization
monitor.

$\delta P \sim 0.1\%$ independent of P_+

[K. Mönig]

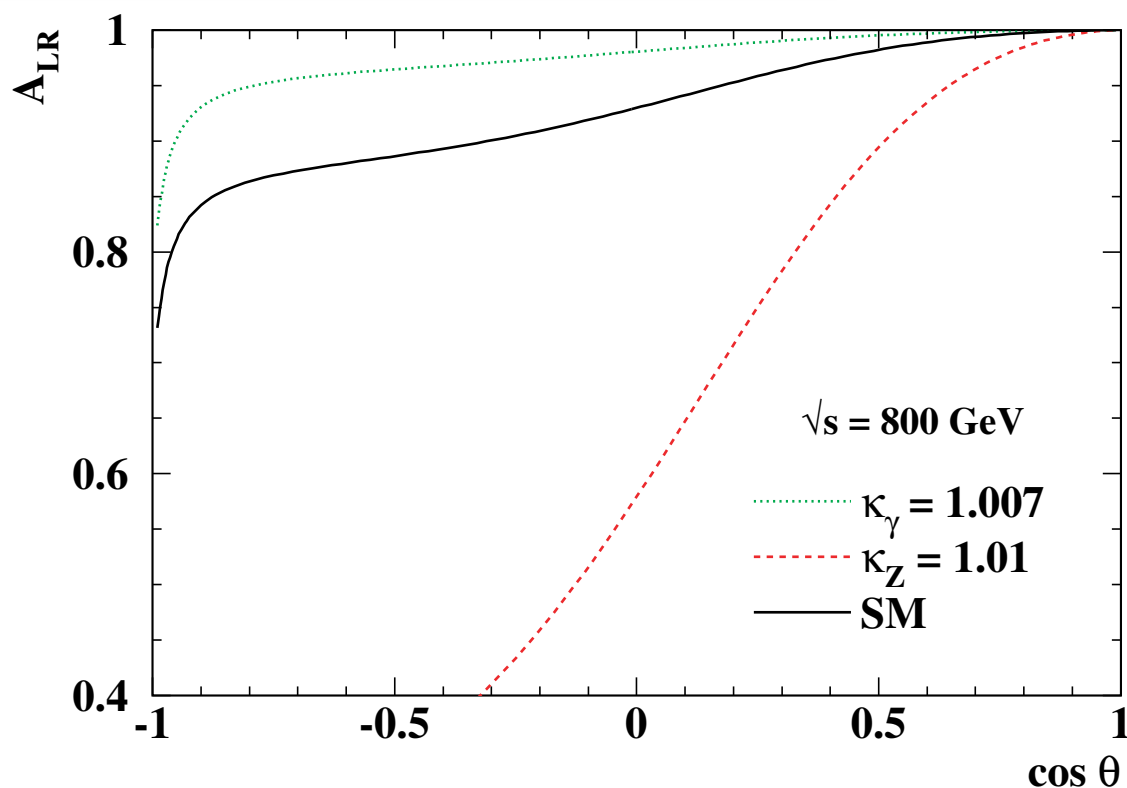

Directly measures $\langle P \rangle$, could be used for central value

No more cross-check (precision)

No information about correlations (e.g. P vs. L)

Experimental systematic uncertainties?



Spectrometer Design

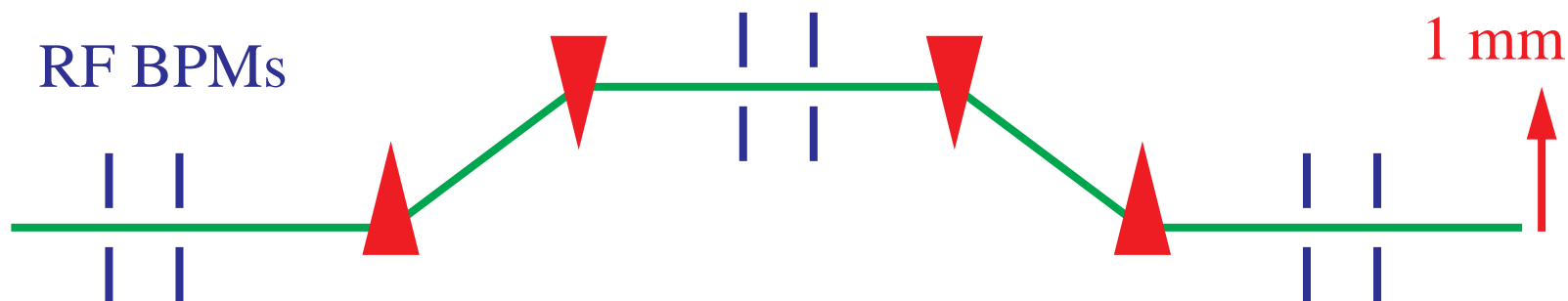

- Bends $\sim 100 \mu\text{Rad}$, lengths 10 m, 1 mm bump
- Need 100 nm (or better) resolution **and accuracy**
- Move BPMs to the beam (keep same relative position)
- Calibrate alignment by turning off chicane

Upstream only, very difficult to control all systematics

- Downstream only
- few mRad bends
- Detect SR
- **Collision diagnostic?**

Must operate in difficult
x-line environment

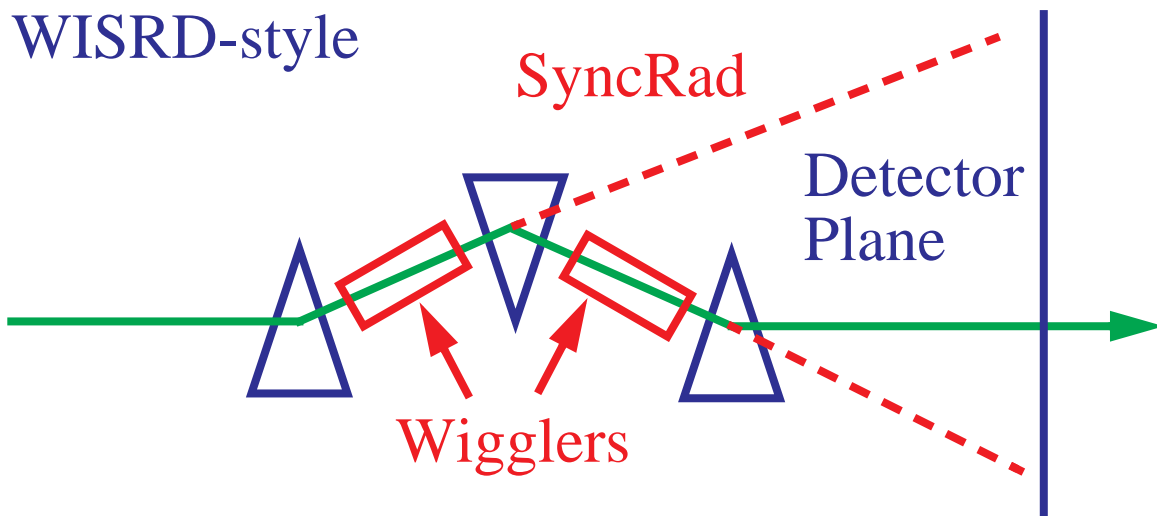

Highly complimentary approaches

Both challenging for 100 ppm absolute measurements



Collision Biases



$\langle \sqrt{s} \rangle - 2 \langle E_b^{in} \rangle$ vs. Vertical Offset (truncated range)

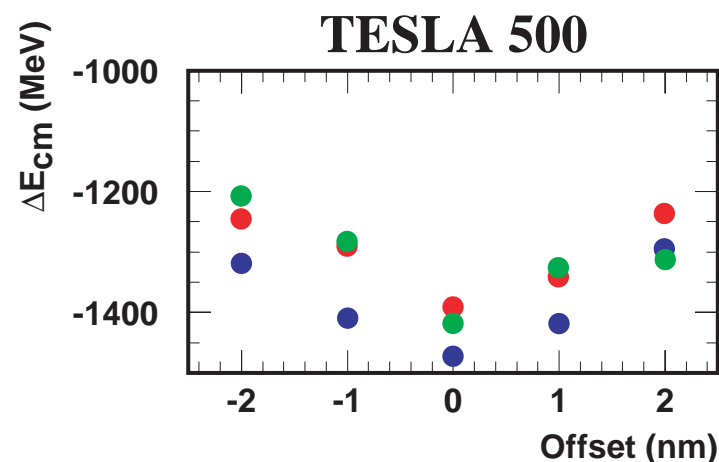
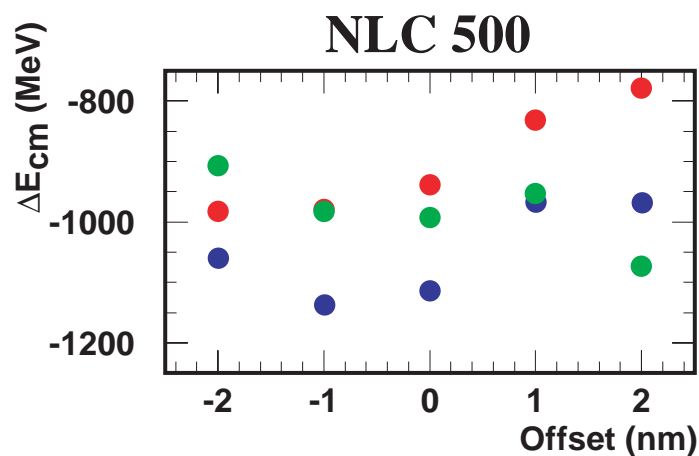

Bias sensitive to fine details of the collision process,
not completely reflected in **Bhabha $dL/d\sqrt{s}$ measurement**

(E vs. z vs. L correlations)

Proposed Solutions (all speculative)

- Downstream spectrometer
- Calibrate with ZZ or Z γ (loose one cross-check)
- Monitor with Bhabha energy, muon curvature
- Accelerator solution

Not an easy problem
Would like a real observable,
reduce simulation dependence



Radiative Returns

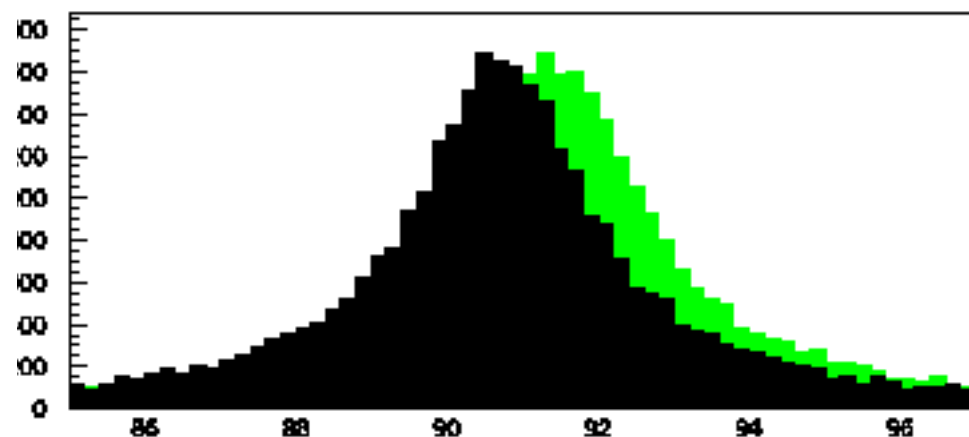
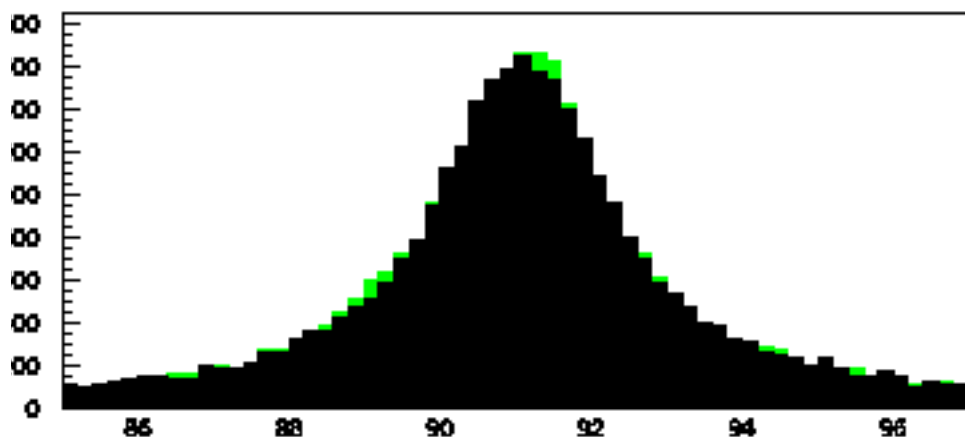
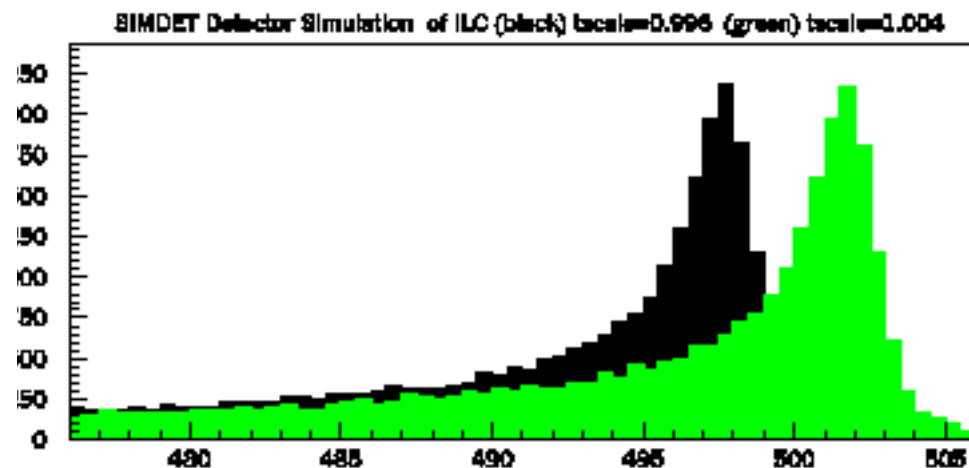
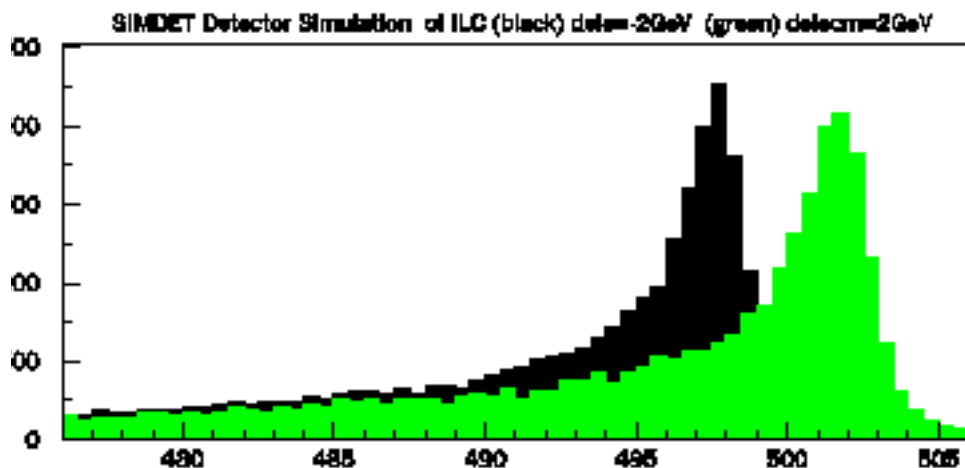

T. Barklow

Possible to separately fit $\langle \sqrt{s} \rangle$ and tracker momentum scale?

K. Mönig also presenting results from Arnd Hinze

100 ppm looks achievable, need separate tracking of variation, need to worry about possible correlations, systematics

Probably the only hope for WW threshold scan...

Other possibilities: ZZ, full energy $\mu^+\mu^-$, ...



Absolute Luminosity

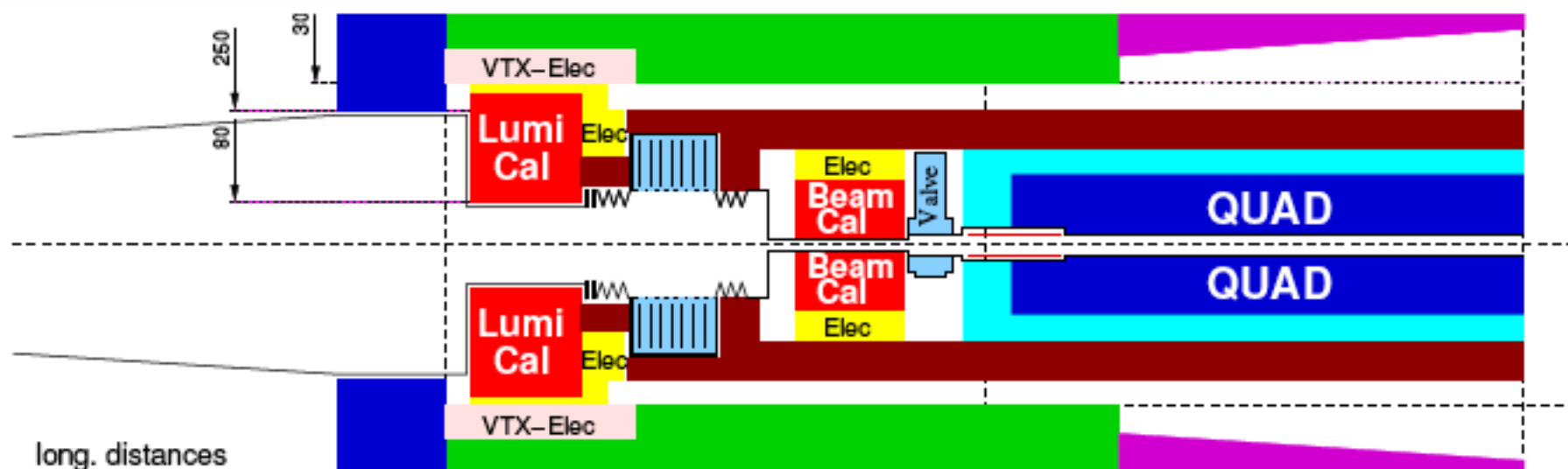

Re-design of forward region (partly) motivated by precision luminosity

Is this motivated at high energy, or only Giga-Z?

Is $\delta L \sim 0.1\%$ good enough for all HE measurements?

Higher precision is always better, but question of cost/benefit and resource allocation. Should the lumi-monitor simply be replaced for Giga-Z running?



Difficult questions



- Do we need beam-based polarimetry better than 0.5% (absolute), or are we satisfied to use physics channels. **Relative is much easier than absolute...**
- Will the improved precision available in P_+ ever be realized, or will this be limited by **switching time?**
- How important fundamentally are Lumi - Energy - Polarization correlations?
- **Is it worth the effort to achieve $\delta L \sim 0.01\%$?**
- Are we satisfied to rely upon physics-based collision energy measurements?
- **How do our assumptions evolve with realistic running conditions? What are the relative risks?**

**Meaningful input from the physics groups
most welcome on these issues...**